



Signa Solo™

Quick Start Guide

Thank you for your Polk purchase. If you have a question or comment, please feel free to call or email us.

Technical Assistance

In North America, call Polk Customer Service at 800-377-POLK(7655) (M-F, 9 a.m.-5:30 p.m. EST)
Outside the US, call +1-410-358-3600

email polkcs@polkaudio.com

Polk Audio
1 Viper Way
Vista, CA 92081

What's in the Box

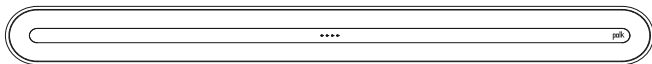

Sound bar



Remote control

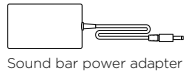

Sound bar power adapter



4' Optical cable



Literature

Connecting Your Signa Solo to Your TV

1. Use the provided Optical cable to connect the sound bar to the TV.

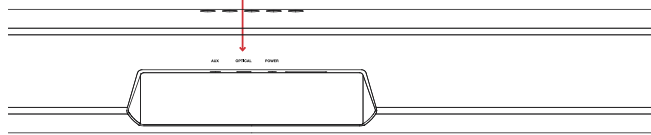
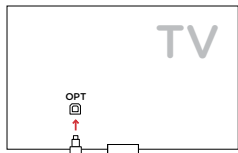

If your TV does not have an Optical output, connect the sound bar to the TV with an AUX cable (not included).

NOTE: Only optical supports Dolby 5.1 decoding.

2. Connect the sound bar power cord to an AC outlet

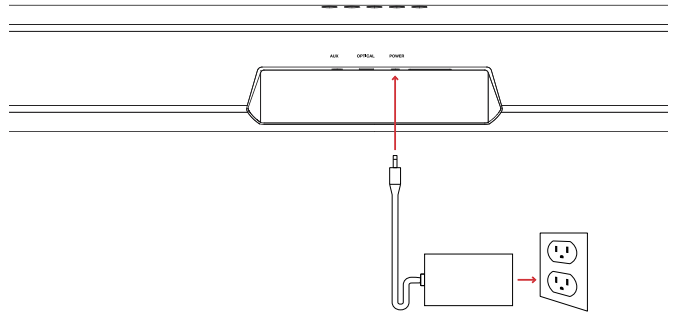

3. Turn on your sound bar
Press the Power button on the sound bar or remote.

NOTE: Make sure TV internal speakers are off when using optical and aux inputs.

Remote Control

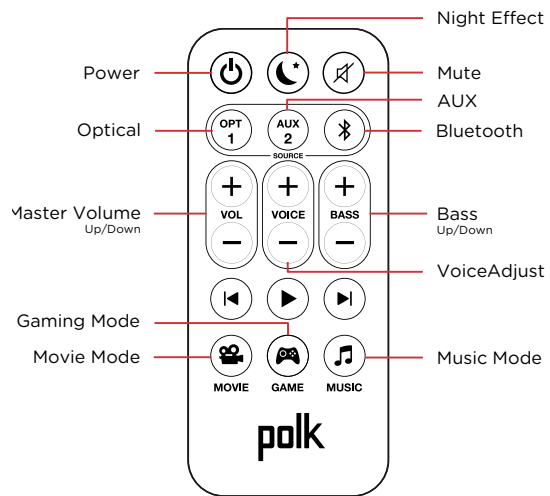

Sound Bar Top Panel

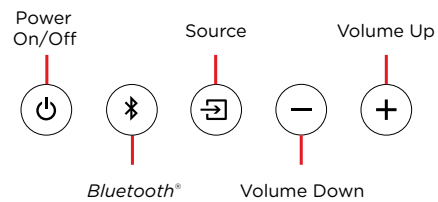

Sound Bar Back Panel

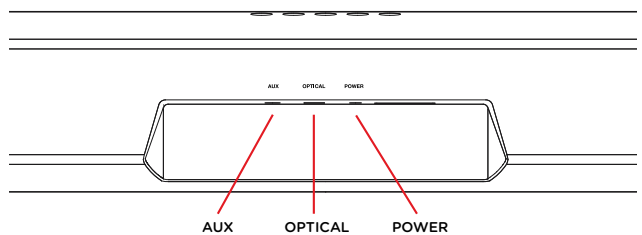

Merci de votre achat de ce produit Polk. Si vous avez des questions ou des commentaires, vous pouvez nous appeler ou communiquer avec nous par courriel.

Assistance technique

En Amérique du Nord, contactez le service à la clientèle de Polk au 800-377-POLK (7655) (L-V, 9 h à 17 h 30, HNE)

À l'extérieur des US, composez le +1-410-358-3600

Courriel polkcs@polkaudio.com

Polk Audio
1 Viper Way
Vista, CA 92081

Ce qu'il y a dans la boîte

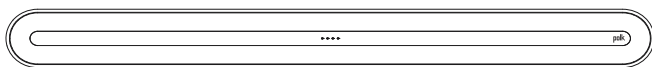

Barre de son

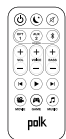

Télécommande

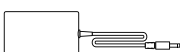

Bloc d'alimentation de la barre de son



Câble optique 4 po



Documentation

Connecter votre Signa Solo à votre téléviseur

- Utilisez le câble optique fourni pour connecter la barre de son à votre téléviseur.

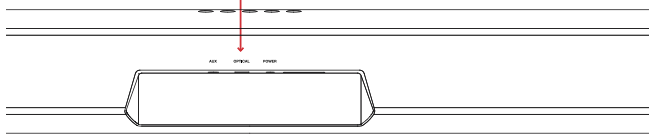
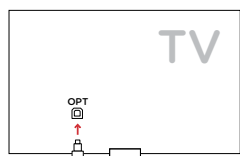

Si votre téléviseur n'est pas muni d'une sortie optique, connectez la barre de son au téléviseur avec un câble auxiliaire (non compris).

REMARQUE : Seule la sortie optique prend en charge le décodage Dolby 5.1.

- Connectez la barre de son à une prise de courant CA

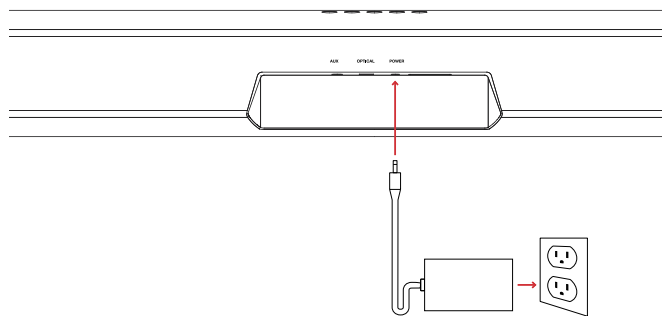

- Allumez votre barre de son
Appuyez sur le bouton d'alimentation de la barre de son ou de la télécommande.

REMARQUE : Veillez à ce que les haut-parleurs internes de téléviseur soient éteints lorsque vous utilisez les entrées optiques ou les entrées auxiliaires.

Télécommande

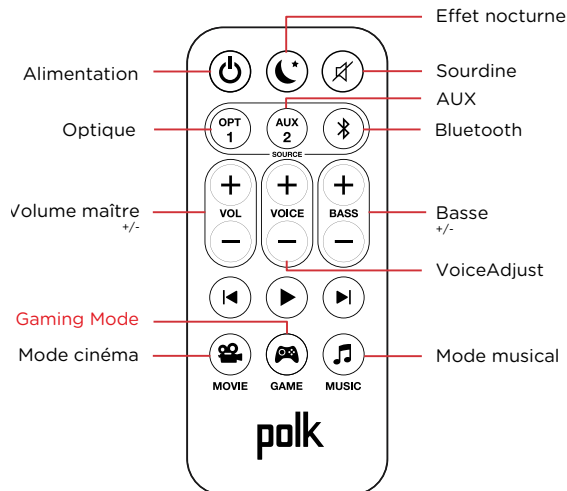

Panneau supérieur de la barre de son

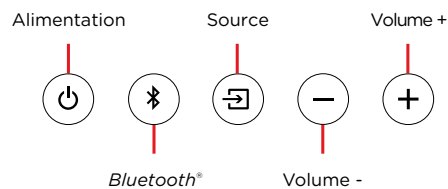

Panneau arrière de la barre de son

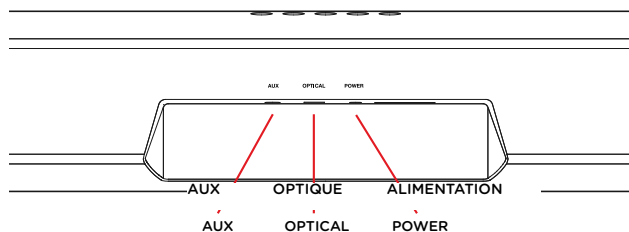

¡Gracias por su compra de Polk. Si tiene alguna pregunta o comentario, por favor, no dude en llamarnos o enviarnos un e-mail.

Asistencia técnica

En Norteamérica, llame al Servicio al cliente de Polk
800-377-POLK(7655) (L-V, 9 a.m. - 5:30 p.m. EST)
Fuera de EE. UU., llame al +1-410-358-3600

email polkcs@polkaudio.com

Polk Audio
1 Viper Way
Vista, CA 92081

Qué incluye la caja

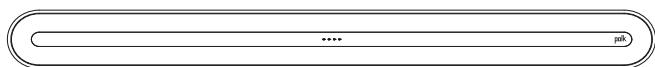

Barra de sonido

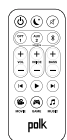

Control remoto

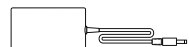

adaptador de corriente de la barra de sonido



Cable óptico de 1,2 m (4 pies)



Manual

Conectar su Signa Solo a su TV

1. Utilice el cable óptico proporcionado para conectar la barra de sonido al TV.

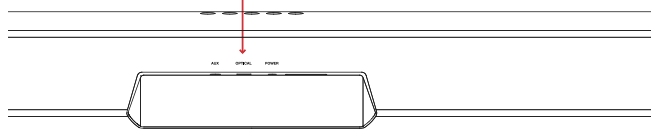
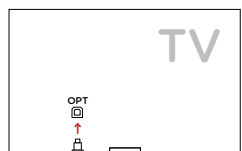

Si su TV no tiene una salida óptica, conecte la barra de sonido al TV con un cable AUX (no incluido).

NOTA: Solo el cable óptico soporta la decodificación Dolby 5.1.

2. Conecte el cable de energía de la barra de sonido a una toma AC

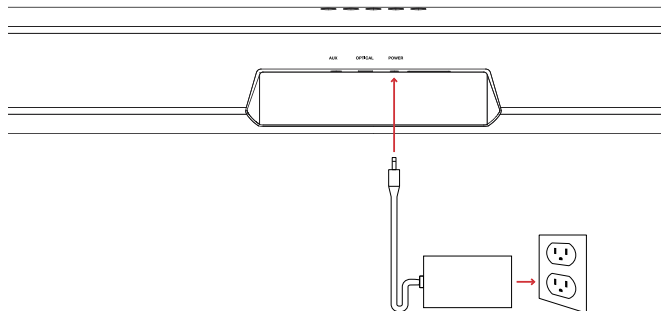

3. Encienda su barra de sonido. Pulse el botón Encendido en la barra de sonido o en el control remoto.

NOTA: Asegúrese de que los altavoces internos del TV estén apagados al utilizar entradas ópticas y aux.

Control Remoto

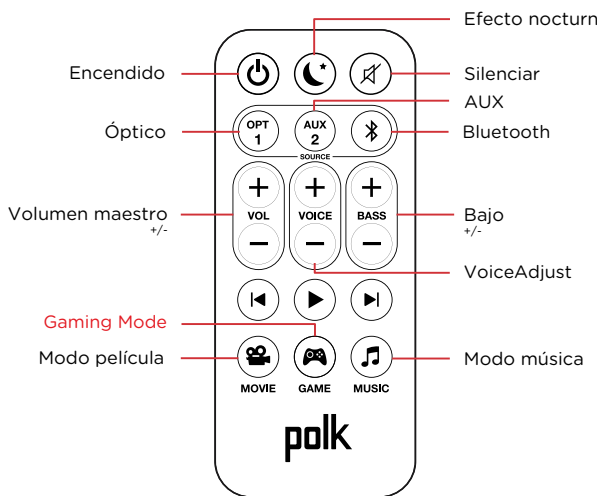

Panel superior de la barra de sonido

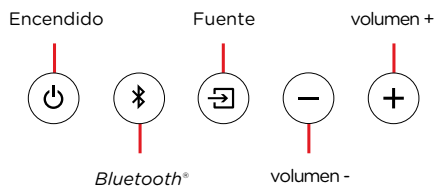

Panel posterior de la barra de sonido

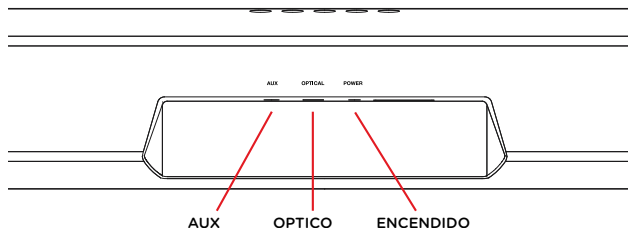

Grazie per aver acquistato un prodotto Polk. Per domande o commenti, chiamateci o inviateci un'email.

Assistenza tecnica

Nel Nord America, chiamate il servizio Clienti POLK al numero 800-377-POLK(7655) (L-V, 9:00-17:30 EST)
Al di fuori degli USA, chiamate al +1-410-358-3600
email polkcs@polkaudio.com

Polk Audio
1 Viper Way
Vista, CA 92081

Contenuto della confezione

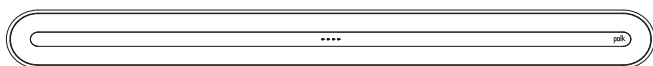

Barra sonora

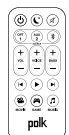

Telecomando

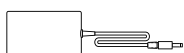

alimentatore barra sonora



Manuale



Cavo ottico da 1,2 m

Collegamento di Signa Solo alla TV

- Utilizzare il cavo ottico in dotazione per collegare la barra sonora alla TV.

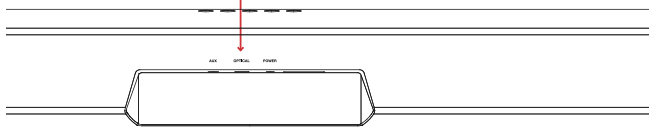
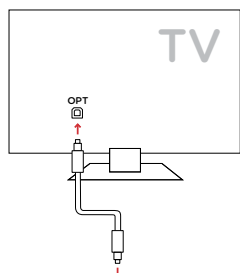

Se la TV non dovesse avere un ingresso per il cavo ottico, collegare la barra sonora alla TV tramite un cavo AUX (non incluso).

NOTA: solo il collegamento ottico supporta la decodifica Dolby 5.1.

- Collegare il cavo di alimentazione della barra sonora ad una presa elettrica

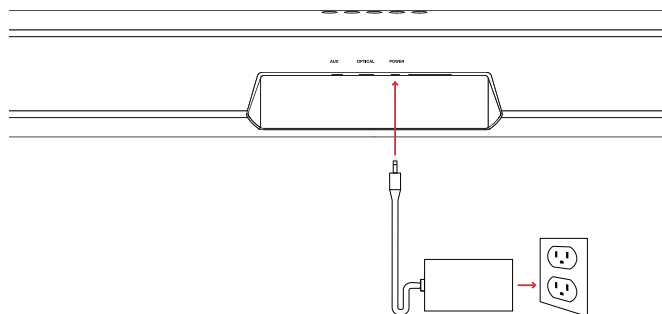

- Accendere la barra sonora
Premere il tasto di accensione nella barra sonora o nel telecomando.

NOTA: assicurarsi che gli altoparlanti interni della TV siano muti quando si utilizzano gli ingressi ottici e AUX.

Telecomando

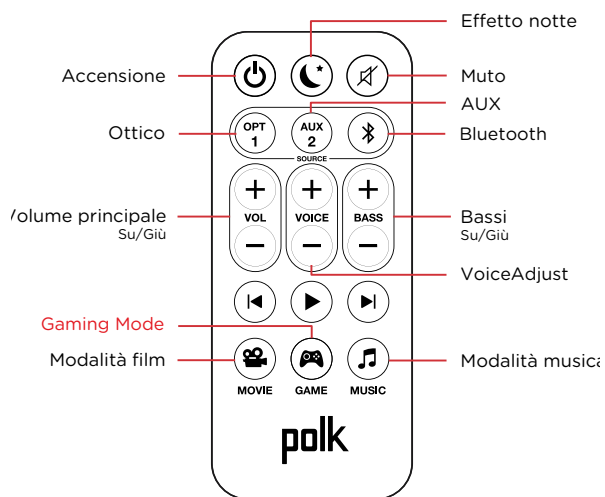

Pannello superiore della barra sonora

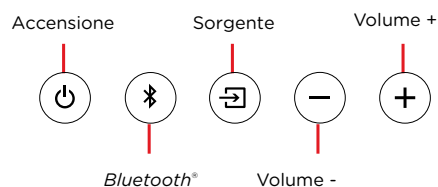

Pannello posteriore della barra sonora

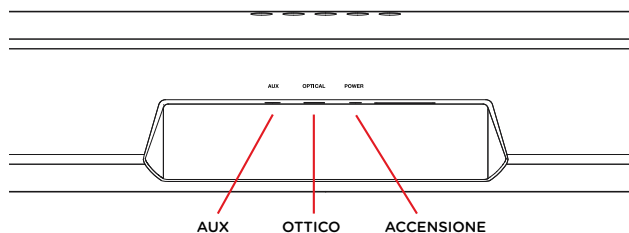

Vielen Dank für Ihren Einkauf. Wenn Sie eine Frage oder einen Kommentar haben, zögern Sie nicht uns anzurufen oder eine E-Mail zu schicken.

Technical Assistance

In Nordamerika erreichen Sie den Polk-Kundendienst unter der folgenden Nummer: 800-377-POLK (7655) (M-F, 9.00 bis 17.00 Uhr, EST)
Außerhalb der USA, wählen Sie bitte + 1-410-358-3600

E-Mail: polkcs@polkaudio.com

Polk Audio
1 Viper Way
Vista, CA 92081

Die komplette Betriebsanleitung finden Sie im Internet unter www.polkaudio.com

Was ist in der Box

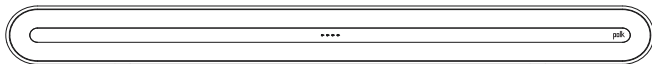

Sound bar



Fernbedienung

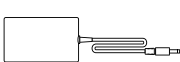

Soundbar Netzteil



Literatur

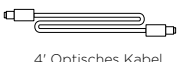

4' Optisches Kabel

Anschließen Ihres Signa Solo an Ihr Fernsehgerät

1. Benutzen Sie das mitgelieferte optische Kabel, um die Soundbar mit dem Fernsehgerät zu verbinden.

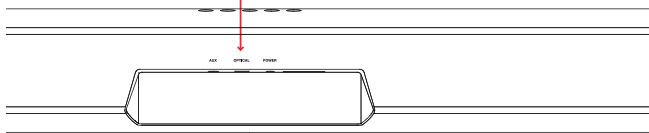
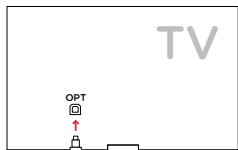

Wenn Ihr Fernsehgerät keinen optischen Ausgang hat, schließen Sie die Soundbar mit einem AUX-Kabel (nicht im Lieferumfang enthalten) an das Fernsehgerät an.

HINWEIS: Nur ein optischer Ausgang unterstützt Dolby 5.1-Decodierung.

2. Schließen Sie das Soundbar-Netz kabel an eine Netzsteckdose an

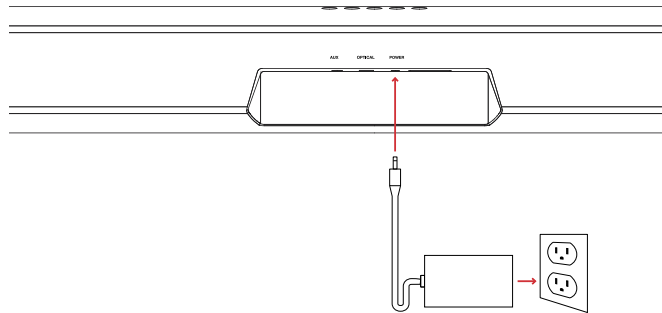

3. Schalten Sie die Soundbar ein
Drücken Sie die Betriebstaste  auf der Soundbar oder der Fernbedienung.

HINWEIS: Vergewissern Sie sich, dass die internen Lautsprecher des Fernsehgeräts ausgeschaltet sind, wenn Sie optische und Aux-Eingänge verwenden.

Fernbedienung

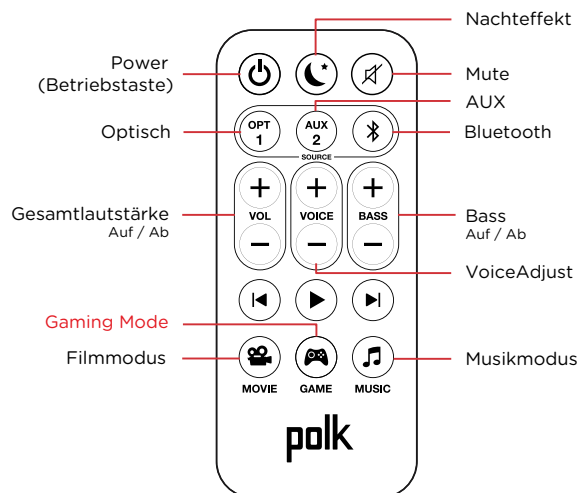

Soundbar-Oberseite

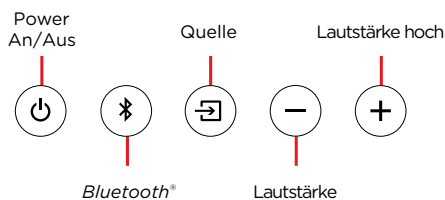

Soundbar-Rückseite

